

**Industrial L2+ Multi-Port Full Gigabit
Managed Ethernet Switches**

IGS-10020MT/IGS-12040MT/IGS-20040MT

Quick Installation Guide

Table of Contents

1. Package Contents	3
2. Requirements.....	4
3. Wiring the Power Inputs	5
3.1 Grounding the Device.....	7
4. Terminal Setup.....	8
4.1 Logging on to the Console.....	9
4.2 Configuring IP Address	10
5. Starting Web Management	12
5.1 Logging in to the Industrial L2+ Managed Switch	13
5.2. Saving Configuration	17
6. Recovering Back to Default Configuration	18
7. Customer Support	20

1. Package Contents

Thank you for purchasing PLANET Industrial L2+ Multi-Port Gigabit Managed Ethernet Switches, such as IGS-10020MT, IGS-12040MT and IGS-20040MT. The descriptions of these models are as follows:

IGS-10020MT	Industrial 8-Port 10/100/1000T + 2-Port 1G/2.5G SFP Managed Switch
IGS-12040MT	Industrial 8-Port 10/100/1000T + 2-Port 100/1G SFP + 2-Port 1G/2.5G SFP Managed Switch
IGS-20040MT	Industrial 16-Port 10/100/1000T + 4-Port 100/1000X SFP Managed Switch

“**Industrial L2+ Managed Switch**” mentioned in this Quick Installation Guide refers to the above three models.

Open the box of the **Industrial L2+ Managed Switch** and carefully unpack it. The box should contain the following items:

- The Industrial L2+ Managed Switch x 1
- Quick Installation Guide x 1
- DIN-rail Kit x 1
- Wall Mounting Kit x 1
- DB9 to RJ45 Interface RS232 Console Cable x 1
(Only IGS-10020MT doesn't have console interface.)
- Dust Cap (Please refer to the table below.)

Item	RJ45 Dust Cap	SFP Dust Cap
IGS-10020MT	8	2
IGS-12040MT	9	4
IGS-20040MT	17	4

If any item is found missing or damaged, please contact your local reseller for replacement.

2. Requirements

- Workstations running Windows XP/2003/2008/2012/Vista/7/8/10, MAC OS X or later, Linux, UNIX, or other platforms are compatible with TCP/IP protocols.

■ Serial Port Connection (Terminal)

- The above Workstations come with COM Port (DB9) or USB-to-RS232 converter.
- The above Workstations have been installed with terminal emulator, such as Hyper Terminal included in Windows XP/2003, putty or tera term.
- Serial cable -- one end is attached to the RS232 serial port, while the other end to the RJ45 console port of the Industrial L2+ Managed Switch.

■ Ethernet Port Connection

- Workstations are installed with Ethernet NIC (Network Interface Card)
- Network cables -- Use standard network (UTP) cables with RJ45 connectors.
- The above PC is installed with Web browser.



Note

It is recommended to use Internet Explorer 8.0 or above to access the Industrial L2+ Managed Switch. If the Web interface of the Industrial L2+ Managed Switch is not accessible, please turn off the anti-virus software or fire-wall and then try it again.

3. Wiring the Power Inputs

The Upper Panel of the Industrial L2+ Managed Switch indicates a DC inlet power socket and consists of one terminal block connector within 6 contacts. Please follow the steps below to insert the power wire.

1. Insert positive/negative DC power wires into Contacts 1 and 2 for Power 1, or Contacts 5 and 6 for Power 2.

■ **IGS-10020MT:** 12-48V DC, 24V AC

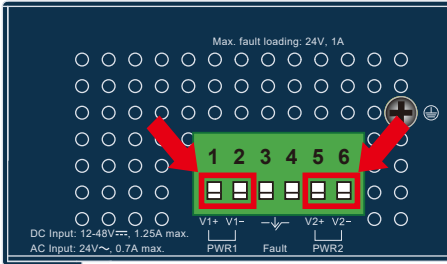

Figure 3-1: IGS-10020MT Upper Panel

■ **IGS-12040MT:** 12~72V DC, 24V AC

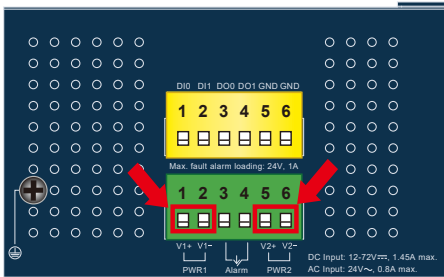

Figure 3-2: IGS-12040MT Upper Panel

■ **IGS-20040MT: 9~48V DC, 24V AC**

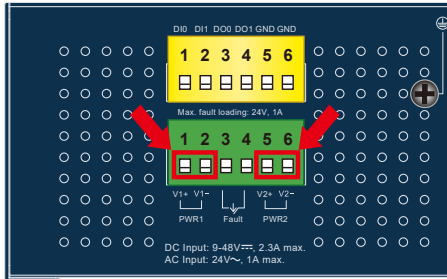
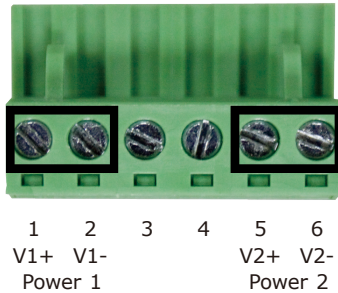

Figure 3-3: IGS-20040MT Upper Panel

2. Tighten the wire-clamp screws for preventing the wires from loosening.



Item	Positive (+) Pin	Negative (-) Pin
IGS-10020MT	Pin 1 / 5	Pin 2 / 6
IGS-12040MT		
IGS-20040MT		



Note

The wire gauge for the terminal block should be in the range from **12** to **24** AWG.

3.1 Grounding the Device

Users **MUST** complete grounding wired with the device; otherwise, a sudden lightning could cause fatal damage to the device.

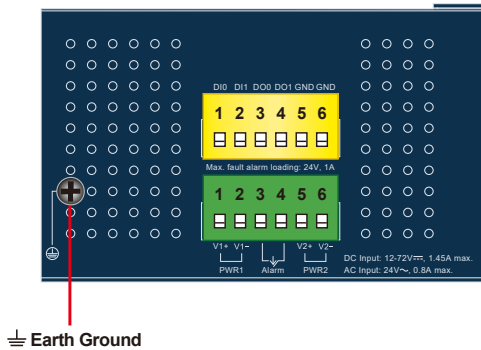

4. Terminal Setup

To configure the system, connect a serial cable to a **COM port** on a PC or notebook computer and to RJ45 type serial (console) port of the Industrial L2+ Managed Switch. The console port of the Industrial L2+ Managed Switch is DCE already, so that you can connect the console port directly through PC without the need of null modem.



Figure 4-1: Industrial L2+ Managed Switch Console Connectivity

A terminal program is required to make the software connected to the Industrial L2+ Managed Switch. Putty or Tera Term may be a good choice.

1. Run terminal program on the OS.
2. When the following screen appears, make sure that the COM port should be configured as:

- ◆ Baud: 115200
- ◆ Parity: None
- ◆ Data Bits: 8
- ◆ Stop Bits: 1
- ◆ Flow Control: None

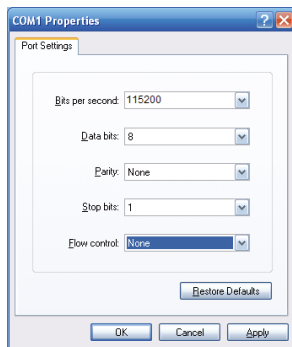

Figure 4-2: COM Port Configuration

4.1 Logging on to the Console

Once the terminal has been connected to the device, power on the Industrial L2+ Managed Switch and the terminal will display “running testing procedures”.



Note

1. There are two switches (IGS-12040MT and IGS-20040MT) that come with the RJ45 type console interface.
2. The following console screen is based on the IGS-12040MT; the display of the IGS-12040MT is the same as that of the IGS-20040MT.

Then, the following message asks to log in user name and password as shown in Figure 4-3. Please enter the factory default user name “**admin**” and password “**admin**”.

User name: **admin**

Password: **admin**

```
COMB - TeraTerm VT
File Edit Setup Control Window Help
+RAM: 0x80000000-0x90000000 [0x80036a20-0x8fffd0ffe available]
FLASH: 0x40000000-0x43ffffff, 1024 x 0x10000 blocks
== Executing boot script in 3.000 seconds - enter ^C to abort
> diag -p
> fis load -x linux
MDS signature validated
Stage1: 0x80100000, length 451592 bytes
Initrd: 0x80600000, length 188416 bytes
Kernel command line: init=/usr/bin/stage2-loader loglevel=4
> exec
Now booting linux kernel:
Base address: 0x80000000 Entry: 0x80100000
Cmdline: init=/usr/bin/stage2-loader loglevel=4
Active fis: linux
[ 0.488960] mx35 spi0.1: NAND SPI Disable
00:00:00 Stage 1 booted
00:00:00 Loading stage2 from NOR flash partition 'linux'
00:00:07 Overall: 6611 ms, ubifs = 182 ms, rootfs 6399 ms of which xz = 0 ms of
which untar = 0 ms
00:00:19 Starting application...
Using existing mount point for /switch/

Press ENTER to get started

Username: admin
Password:
IGS-12040MT#
```

Figure 4-3: Console Login Screen



Note

1. For security reason, **please change and memorize the new password after this first setup.**
2. Only accept command in lowercase letter under console interface.

4.2 Configuring IP Address

The Industrial L2+ Managed Switch is shipped with default IP address shown below:

IP Address: **192.168.0.100**
Subnet Mask: **255.255.255.0**

To check the current IP address or modify a new IP address for the Industrial L2+ Managed Switch, please use the procedure as follows:

■ Display of the current IP Address

1. At the “#” prompt, enter “**show ip interface brief**”.
2. The screen displays the current IP address shown in Figure 4-4.

```
Press ENTER to get started
Username: admin
Password:
IGS-12040MT# show ip interface brief
Interface Address Method Status
-----
VLAN 1 192.168.0.100/24 Manual UP
IGS-12040MT#
```

Figure 4-4: IP Information Screen

■ Configuration of the IP Address

3. At the “#” prompt, enter the following command and press **<Enter>** as shown in Figure 4-5.

```
IGS-12040MT# configure terminal
IGS-12040MT(config)# interface vlan 1
IGS-12040MT(config-if-vlan)# ip address 192.168.1.100 255.255.255.0
IGS-12040MT(config-if-vlan)#
```

The previous command would apply the following settings for the Industrial L2+ Managed Switch.

IP Address: **192.168.1.100**
Subnet Mask: **255.255.255.0**

```

Press ENTER to get started
Username: admin
Password:
IGS-12040MT# show ip interface brief
Interface Address Method Status
-----
VLAN 1 192.168.0.100/24 Manual UP
IGS-12040MT# configure terminal
IGS-12040MT(config)# interface vlan 1
IGS-12040MT(config-if-vlan)# ip address 192.168.1.100 255.255.255.0
IGS-12040MT(config-if-vlan)#

```

Figure 4-5: Configuring IP Address Screen

4. Repeat step 1 to check if the IP address has changed.

■ Storing the current switch configuration

5. At the “#” prompt, enter the following command and press <Enter>.

copy running-config startup-config

```

Press ENTER to get started
Username: admin
Password:
IGS-12040MT# show ip interface brief
Interface Address Method Status
-----
VLAN 1 192.168.0.100/24 Manual UP
IGS-12040MT# configure terminal
IGS-12040MT(config)# interface vlan 1
IGS-12040MT(config-if-vlan)# ip address 192.168.1.100 255.255.255.0
IGS-12040MT(config-if-vlan)# exit
IGS-12040MT(config)# exit
IGS-12040MT# copy running-config startup-config
Building configuration...
do not reset or power off the device!
% Saving 3916 bytes to flash:startup-config
IGS-12040MT#

```

Figure 4-6: Saving Current Configuration Command Screen

If the IP is successfully configured, the Industrial L2+ Managed Switch will apply the new IP address setting immediately. You can access the Web interface of the Industrial L2+ Managed Switch through the new IP address.



Note

If you are not familiar with the console command or the related parameter, enter “**help**” anytime in console to get the help description.

5. Starting Web Management

The following shows how to start up the **Web Management** of the Industrial L2+ Managed Switch. Note the Industrial L2+ Managed Switch is configured through an Ethernet connection. Please make sure the manager PC must be set to the same **IP subnet address**.

For example, the default IP address of the Industrial L2+ Managed Switch is **192.168.0.100**, then the manager PC should be set to **192.168.0.x** (where x is a number between 1 and 254, except 100), and the default subnet mask is 255.255.255.0.

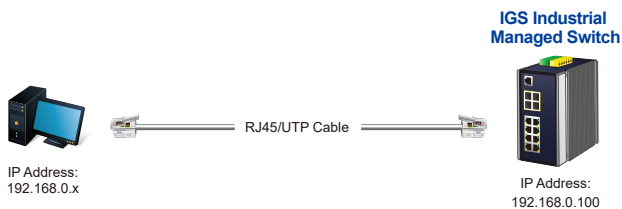

Figure 5-1: IP Management Diagram

5.1 Logging in to the Industrial L2+ Managed Switch

1. Use Internet Explorer 8.0 or above for Web browser and enter IP address **http://192.168.0.100** (the factory-default IP address) to access the Web interface.
2. When the following dialog box appears, please enter the default user name "**admin**" and password "**admin**" (or the password you have changed before) as shown in Figure 5-2.

Default IP Address: **192.168.0.100**

Default User Name: **admin**

Default Password: **admin**

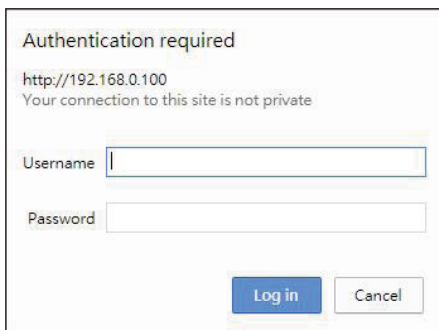

The screenshot shows a web browser dialog box titled "Authentication required". The URL "http://192.168.0.100" is displayed, along with the warning "Your connection to this site is not private". Below this, there are two input fields: "Username" and "Password". At the bottom right of the dialog, there are two buttons: "Log in" and "Cancel".

Figure 5-2: Web Login Screen



Note

The following web screen is based on the IGS-10020MT; the display of the IGS-10020MT is the same as that of the IGS-12040MT and IGS-20040MT.

3. After entering the password, the main screen appears as shown in Figure 5-3.



Figure 5-3: Web Main Screen of Industrial L2+ Managed Switch

The Switch Menu on the top of the Web page lets you access all the commands and statistics the Industrial L2+ Managed Switch provides. The Switch Menu always contains one or more buttons, such as **“System”**, **“Switching”**, **“QoS”**, **“Security”**, **“Ring”**, **“ONVIF”** and **“Maintenance”**.



Figure 5-4: Switch Menu

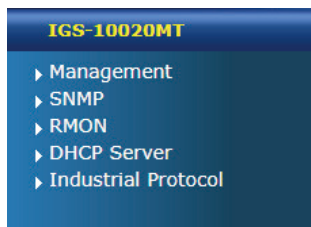

Figure 5-5: Switch Menu -- System

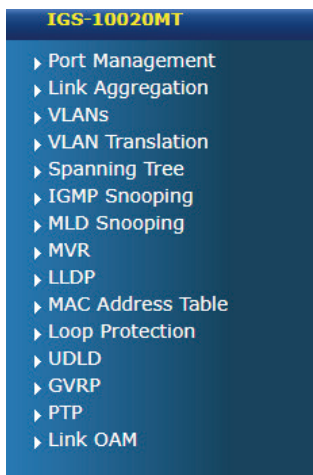

Figure 5-6: Switch Menu – Switching

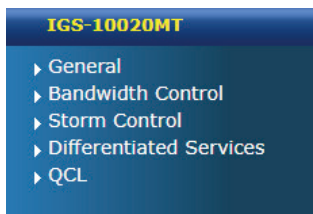

Figure 5-7: Switch Menu – QoS

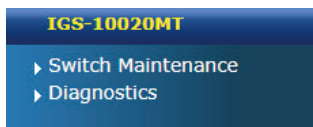

Figure 5-8: Switch Menu – Maintenance



Figure 5-9: Switch Menu -- Security



Figure 5-10: Switch Menu – Ring



Figure 5-11: Switch Menu – ONVIF



Note

If you are not familiar with Switch functions or the related parameter, press **"Help icon"** anytime on the Web page to get the help description.

Now, you can use the Web management interface to continue the Switch management or manage the Switch by console interface. Please refer to the user's manual for more details.

5.2. Saving Configuration

To save all applied changes and set the current configuration as a startup configuration on the Web user interface, the startup-configuration file will be loaded automatically across a system reboot.

1. Click the **Save** icon on the top Switch Menu bar.

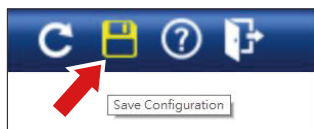
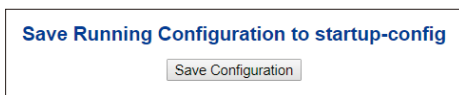

Figure 5-12: Save Config -- Hot Key

2. Press the **"Save Configuration"** button.



3. Or the other way to save the setting is to Click **Maintenance, Save Startup Config.**

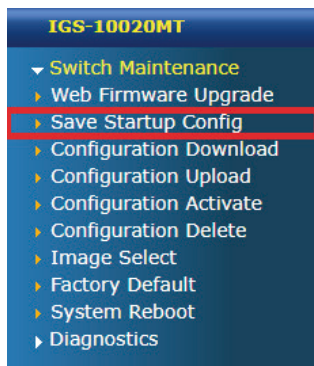

Figure 5-13: Save Config -- Maintenance

6. Recovering Back to Default Configuration

To reset the IP address to the default IP address “192.168.0.100” and the user password to factory default mode (default password is **admin**), press the hardware-based reset button on the front panel for about 10 seconds. After the device is rebooted, you can log in the management Web interface within the same subnet of 192.168.0.xx and default password. Be noted that all the previous setups will be disappeared after the factory default reset is made.

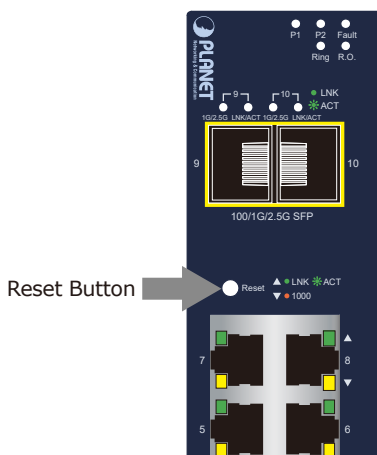

Figure 6-1: IGS-10020MT Reset Button

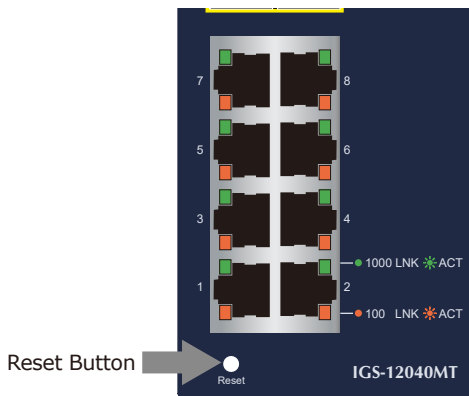

Figure 6-2: IGS-12040MT Reset Button

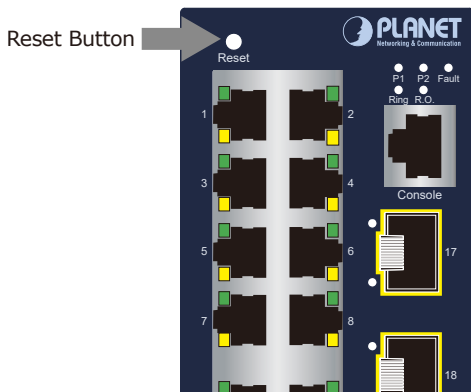

Figure 6-3: IGS-20040MT Reset Button

7. Customer Support

Thank you for purchasing PLANET products. You can browse our online FAQ resource on PLANET web site first to check if it could solve your issue. If you need more support information, please contact PLANET switch support team.

PLANET online FAQs:

<http://www.planet.com.tw/en/support/faq>

Switch support team mail address:

support@planet.com.tw

IGS-10020MT/IGS-10080MFT/IGS-12040MT/IGS-20040MT User's Manual:

<https://www.planet.com.tw/en/support/downloads?&method=keyword&keyword=IGS&view=3#list>



(Please select your switch model name from the Product Model drop-down menu.)

Copyright © PLANET Technology Corp. 2021.

Contents are subject to revision without prior notice.

PLANET is a registered trademark of PLANET Technology Corp.

All other trademarks belong to their respective owners.